

NOXION®



Installation Manual

Compatible with these Noxion Naga RF sets

8719157055666, 8719157055673, 8719157055680, 8719157055697,
8719157055703, 8719157055710, 8719157055727, 8719157055734

This manual provides step-by-step instructions for the installation and connection of your LED-strip. Follow the steps carefully to ensure a correct and safe installation.

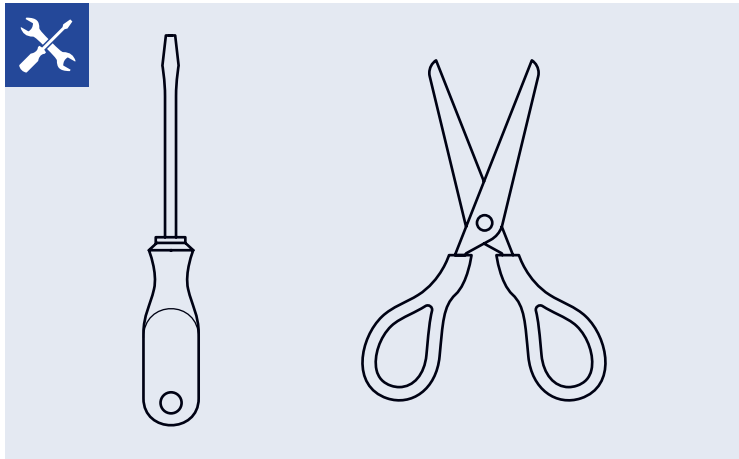
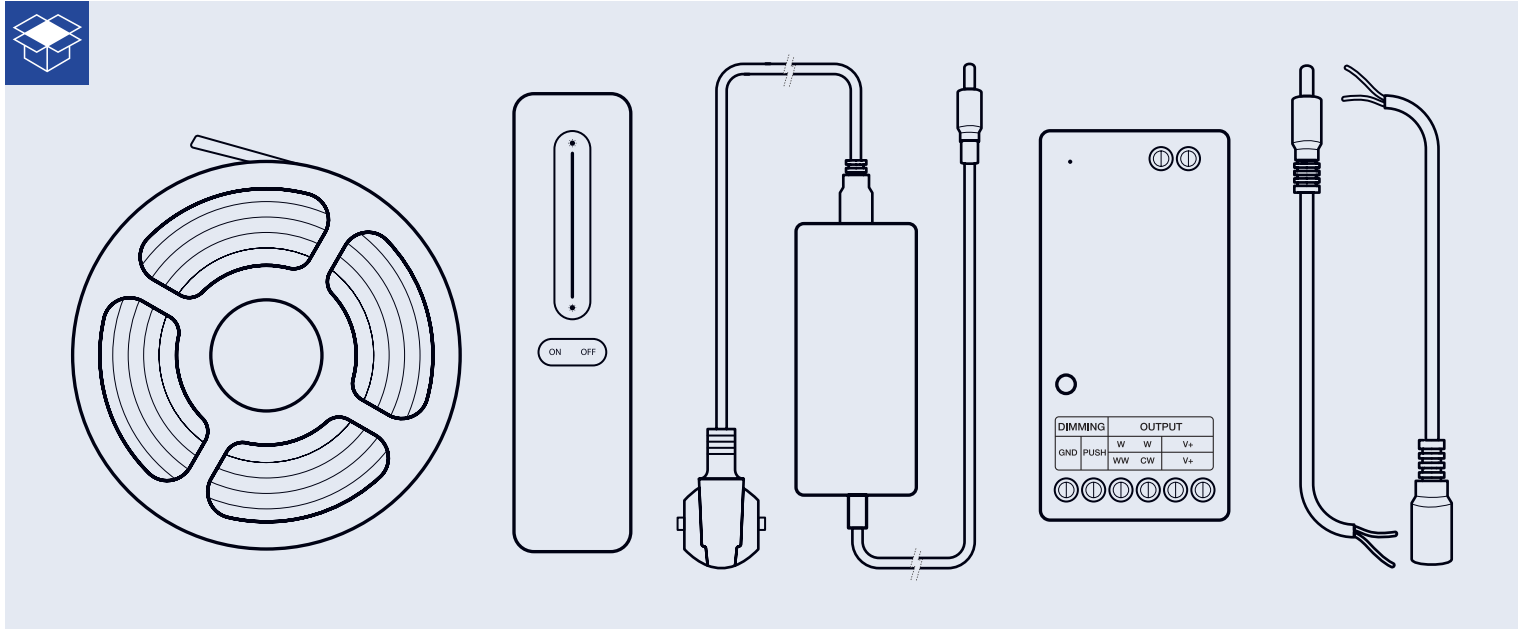

IP Rating and Installation Environment

Ensure that the IP rating of the LED strip is suitable for the environment in which you plan to install it. For example, use IP20-rated strips in dry indoor areas and IP65-rated strips in damp environments. An incorrect IP rating can lead to damage or hazardous situations.

Working with Electricity

Always turn off the power before beginning the installation to prevent the risk of electric shock. Use insulated tools and follow applicable safety guidelines when working with electrical components.

Inspect Components for Damage

Examine all parts, such as the LED strip, power adapter, and connecting cables, for any damage before starting the installation. Damaged components can lead to malfunctions or safety risks.

By observing these precautions, you ensure a safe and durable installation of your LED strips.

1 Unroll the LED Strip



Unroll the LED strip completely to prevent heat buildup.

2 Cutting the LED Strip to Size (OPTIONAL)

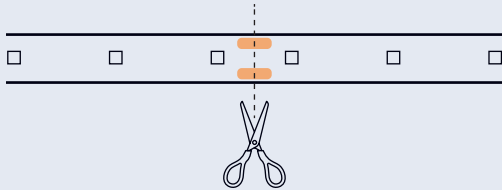

You can cut the LED strip to your desired length. Only cut along the designated cut lines to avoid damage. Work carefully to maintain the functionality of the LED strip.

3 Connecting the Controller

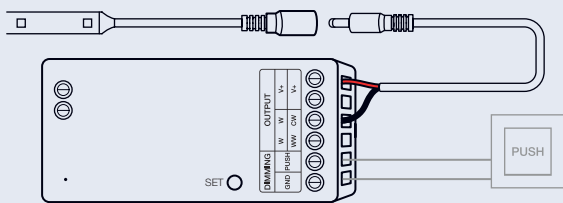

Connect the black wire of the connecting cable to the port labeled "CW" and the red wire to the port labeled "V+". Use a flat-head screwdriver for this. Then, connect the other end of the connecting cable to the LED strip.

In case you wish to use a push switch, connect it as indicated.

4 Connecting the Power Adapter

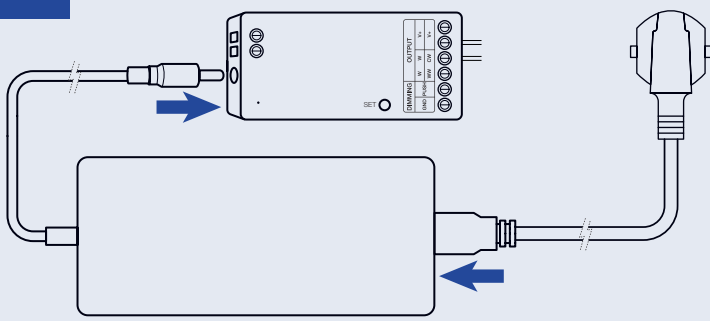

Connect the power adapter to the controller. Then, plug the power cable into the power adapter.

5 Testing the Connection

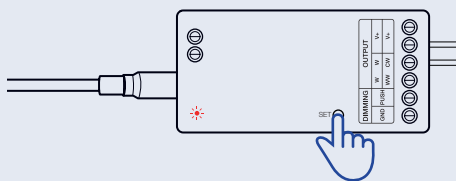

Ensure the power cable is connected to a working power outlet. Then, press the **SET** button on the controller one time to activate until the status light turns red. The LED strip should now light up.

6 Pairing the Remote Control

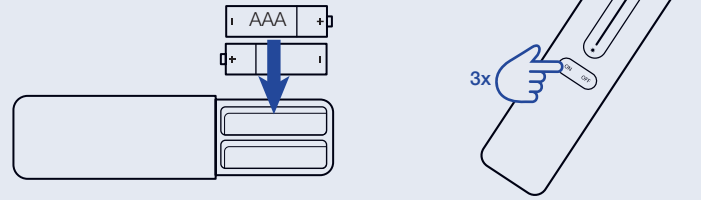

Insert two AAA batteries into the remote control. Turn off the lights by unplugging the power cord from the outlet for 10 seconds. Then, plug the power cord back into the outlet. Within 3 seconds of restoring power, press the **ON** button on the remote control three times in quick succession. The pairing is successful when the LED strip blinks slowly three times.

! If the LED strip does not blink, the pairing has failed. In this case, repeat step 6. Note: Pairing cannot be redone once a successful pairing has been established.

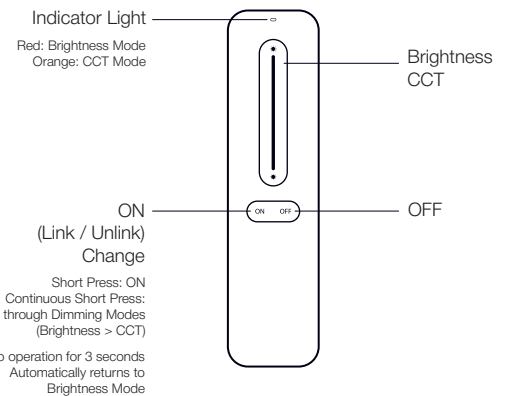

7 Mounting the LED Strip

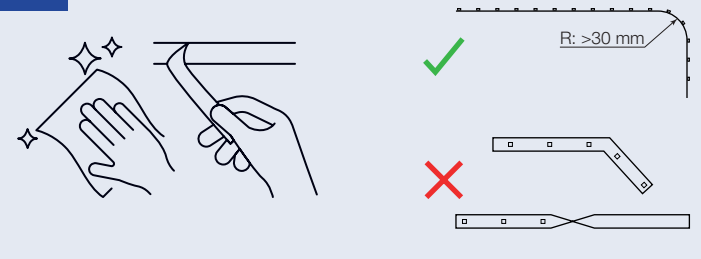

Prepare the surface where you will mount the LED strip. Ensure the surface is smooth, non-porous, and free from dust and grease. Use the 3M adhesive strip on the underside of the LED strip to mount it to the surface.

Storage and Maintenance

Store the LED strip in a dry environment at temperatures between 0 and 30°C. Ensure that the LED strip remains free from dust. Maintain the LED strip by regularly wiping it with a dry, soft cloth. Do not use damp cleaning agents.

Disposal

The LED strip should not be disposed of with household waste. For responsible disposal, the LED strip should be taken to a collection point for electronic equipment.